

Data Link Layer – Part II

Lecturers: Prof. Xiaoming Fu, Dr. Yali Yuan

Assistant: Yachao Shao, MSc

Link Layer

- 2.1 Introduction and services
- 2.2 Error detection and correction
- 2.3 Multiple access protocols
- 2.4 Link-layer Addressing
- 2.5 Ethernet
- 2.6 Link-layer switches
- 2.7 PPP
- 2.8 Wireless links / Wi-Fi
- 2.9 Link Virtualization: ATM, MPLS

Switch

- link-layer device: smarter than hubs, take *active* role
 - store, forward Ethernet frames
 - examine incoming frame's MAC address, **selectively** forward frame to one-or-more outgoing links when frame is to be forwarded on segment, uses CSMA/CD to access segment
- *transparent*
 - hosts are unaware of presence of switches
- *plug-and-play, self-learning*
 - switches do not need to be configured

Switch: allows *multiple* simultaneous transmissions

- hosts have dedicated, direct connection to switch
- switches buffer packets
- Ethernet protocol used on *each* incoming link, but no collisions; full duplex
 - each link is its own collision domain
- **switching**: A-to-A' and B-to-B' simultaneously, without collisions
 - not possible with dumb hub

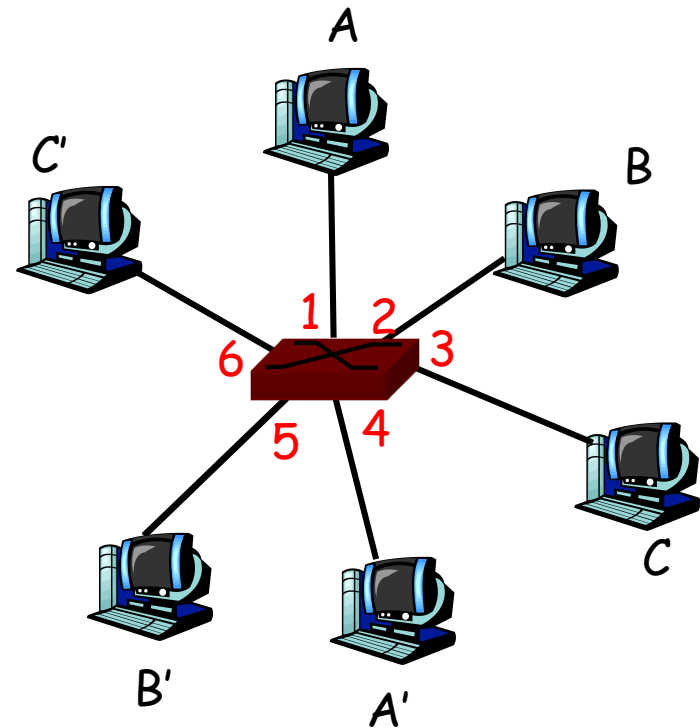

switch with six interfaces
(1,2,3,4,5,6)

Switch Table

- **Q:** how does switch know that A' reachable via interface 4, B' reachable via interface 5?
- **A:** each switch has a **switch table**, each entry:
 - (MAC address of host, interface to reach host, time stamp)
- **Q:** how are entries created, maintained in switch table?
 - something like a routing protocol?

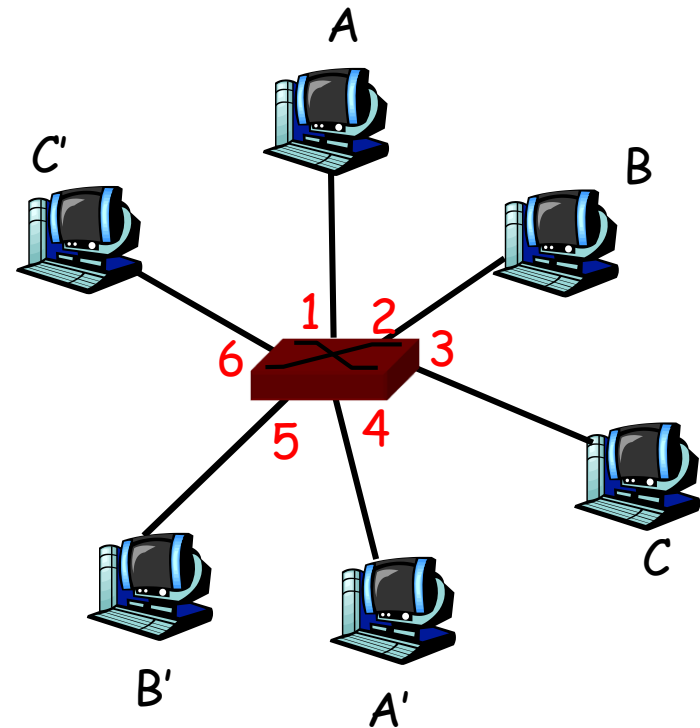

*switch with six interfaces
(1,2,3,4,5,6)*

Switch: self-learning

- switch *learns* which hosts can be reached through which interfaces
 - when frame received, switch “learns” location of sender: incoming LAN segment
 - records sender/location pair in switch table

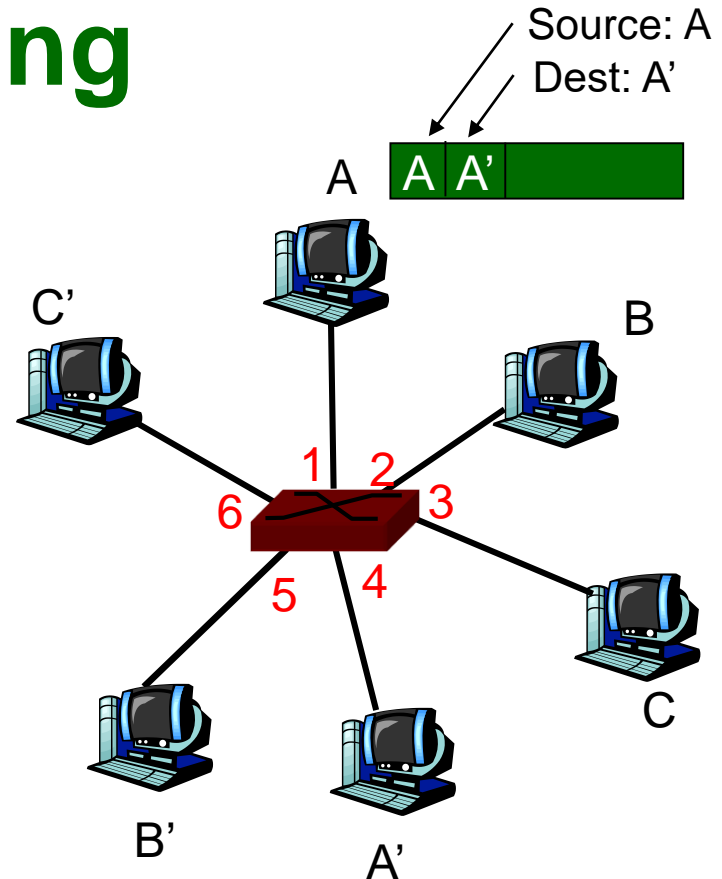

MAC addr	interface	TTL
A	1	60

*Switch table
(initially empty)*

Switch: frame filtering/forwarding

When frame received:

1. record link associated with sending host
2. index switch table using MAC dest address
- 3. if** entry found for destination
then {
 - if** dest on segment from which frame arrived
then drop the frame
 - else** forward the frame on interface indicated**}**

else flood

*forward on all but the interface
on which the frame arrived*

Self-learning, forwarding: example

- frame destination unknown: *flood*
- destination A location known: *selective send*

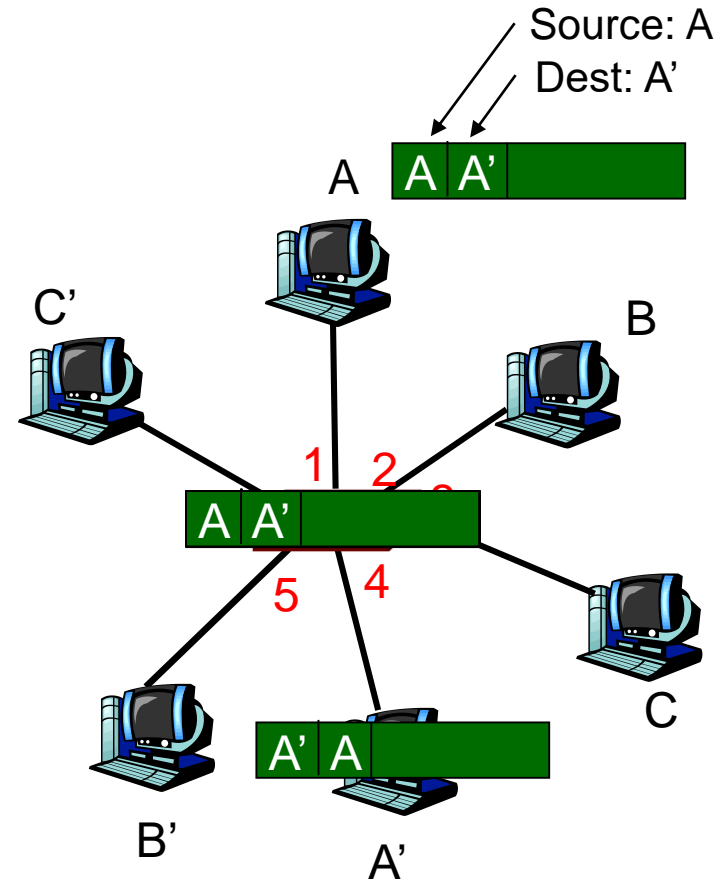

MAC addr	interface	TTL
A	1	60
A'	4	60

*Switch table
(initially empty)*

Interconnecting switches

- switches can be connected together

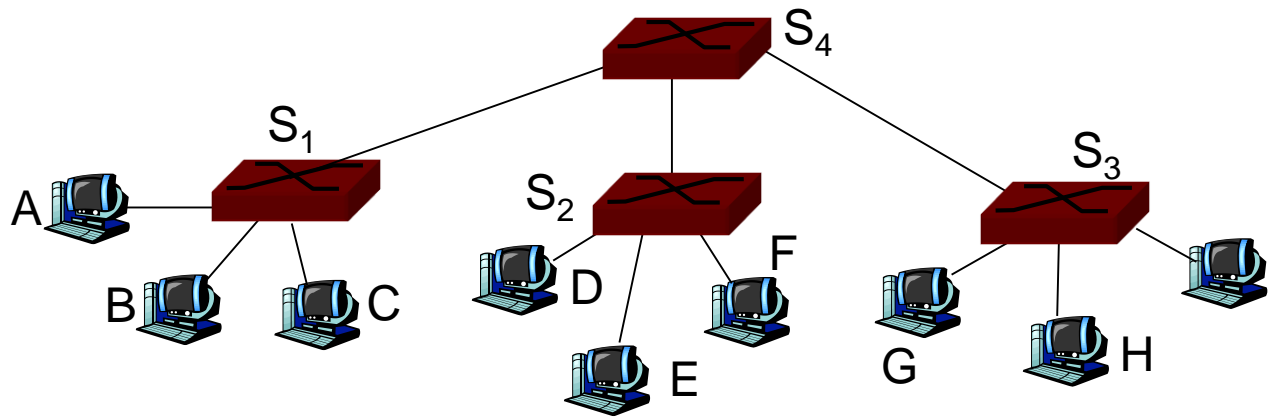

- **Q:** sending from A to G - how does S₁ know to forward frame destined to F via S₄ and S₃?
- **A:** self learning! (works exactly the same as in single-switch case!)

Institutional network (e.g. GöNet)

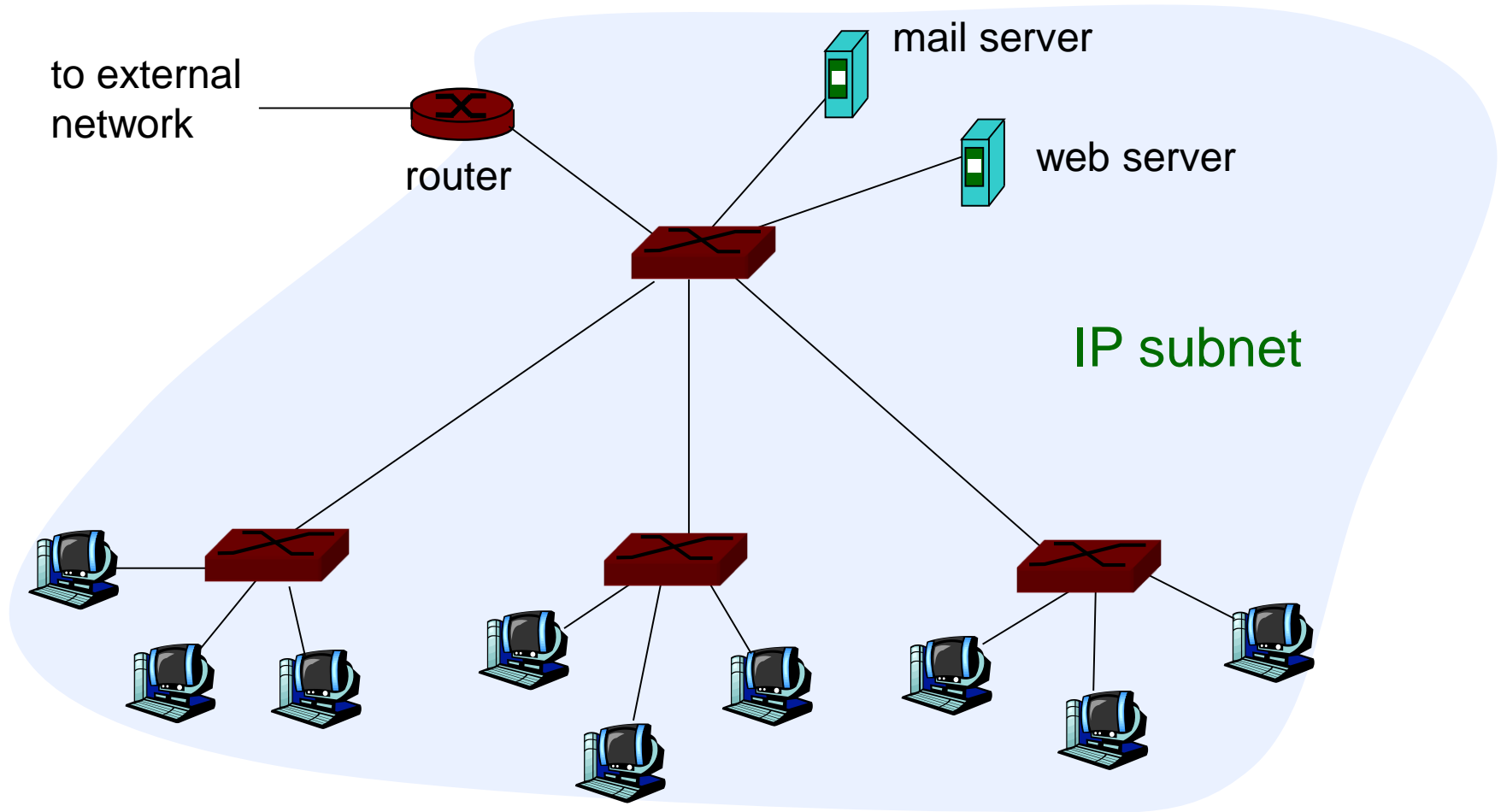

Switches vs. Routers

- both store-and-forward devices
 - routers: network layer devices (examine network layer headers)
 - switches are link layer devices
- routers maintain routing tables, implement routing algorithms - not plug and play, but more sophisticated
- switches maintain switch tables, learning algorithms - plug and play, fast

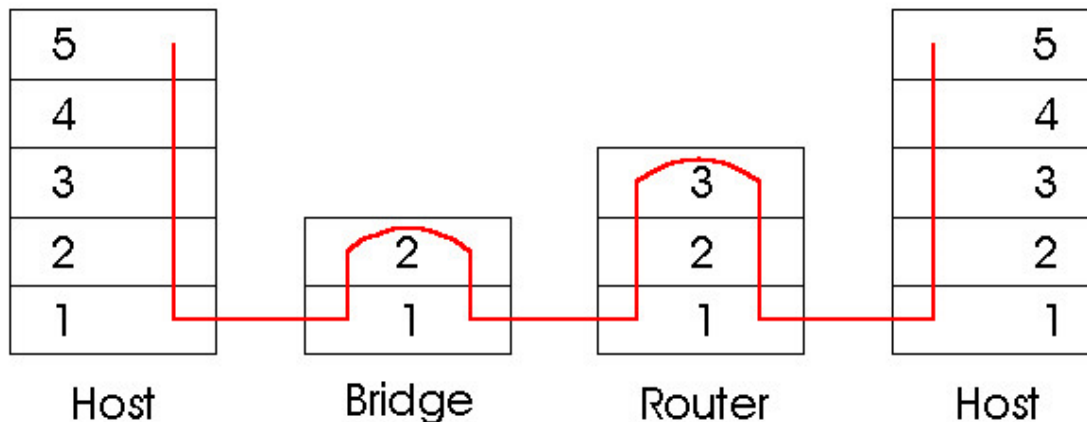

Link Layer

- 5.1 Introduction and services
- 5.2 Error detection and correction
- 5.3 Multiple access protocols
- 5.4 Link-Layer Addressing
- 5.5 Ethernet
- 5.6 Link-layer switches
- 5.7 PPP
- 5.8 Wireless links / Wi-Fi
- 5.9 Link Virtualization: ATM, MPLS

Point to Point Data Link Control

- one sender, one receiver, one link: easier than broadcast link:
 - no Media Access Control
 - no need for explicit MAC addressing
 - e.g., dialup link, ISDN line
- popular point-to-point DLC protocol:
 - PPP (point-to-point protocol)

PPP Design Requirements [RFC 1557]

- **packet framing:** encapsulation of network-layer datagram in data link frame
 - carry network layer data of any network layer protocol (not just IP) *at same time*
 - ability to demultiplex upwards
- **bit transparency:** must carry any bit pattern in the data field
- **error detection** (no correction)
- **connection liveness:** detect, signal link failure to network layer
- **network layer address negotiation:** endpoint can learn/configure each other's network address

PPP non-requirements

- no error correction/recovery
- no flow control
- out of order delivery OK
- no need to support multipoint links (e.g., polling)

Error recovery, flow control, data re-ordering
all relegated to higher layers!

PPP Data Frame

- **Flag:** delimiter (framing)
- **Address:** does nothing (only one option)
- **Control:** does nothing; in the future possible multiple control fields
- **Protocol:** upper layer protocol to which frame delivered (eg, PPP-LCP, IP, IPCP, etc)

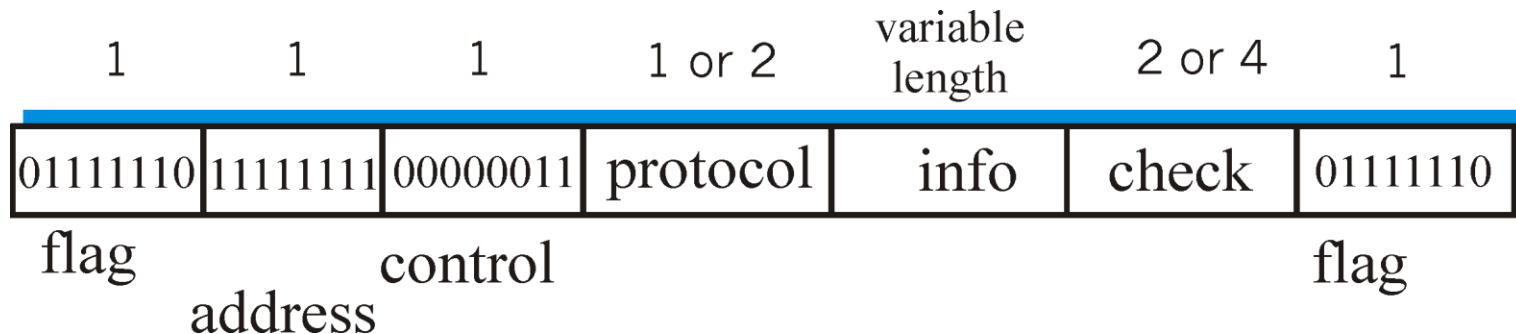

PPP Data Frame

- **info:** upper layer data being carried
- **check:** cyclic redundancy check for error detection

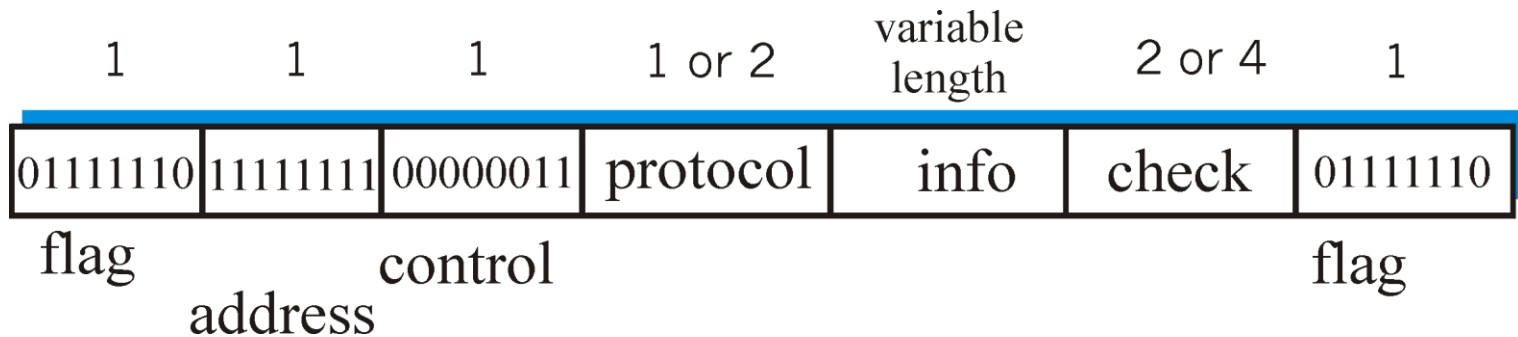

Byte Stuffing

- “data transparency” requirement: data field must be allowed to include flag pattern <01111110>
 - **Q:** is received <01111110> data or flag?
 - Solution: forbid higher layers to use pattern?
 - PPP should be transparent
- **Sender:** adds (“stuffs”) extra < 01111110> byte after each < 01111110> *data* byte
- **Receiver:**
 - two 01111110 bytes in a row: discard first byte, continue data reception
 - single 01111110: flag byte

Byte Stuffing

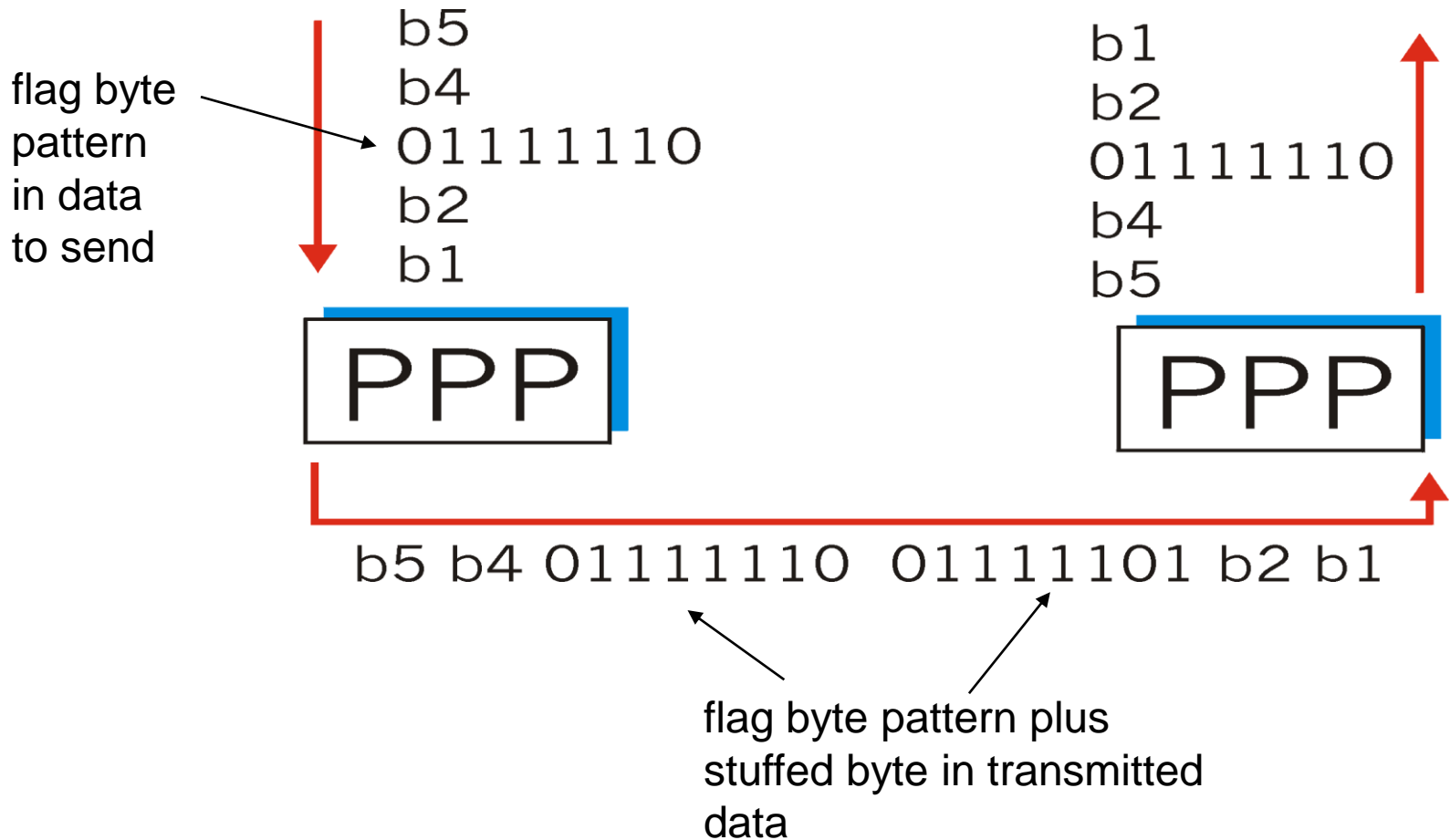

Link Layer

- 2.1 Introduction and services
- 2.2 Error detection and correction
- 2.3 Multiple access protocols
- 2.4 Link-Layer Addressing
- 2.5 Ethernet
- 2.6 Link-layer switches
- 2.7 PPP
- 2.8 Wireless links / Wi-Fi
- 2.9 Link Virtualization: ATM, MPLS

Elements of a wireless network

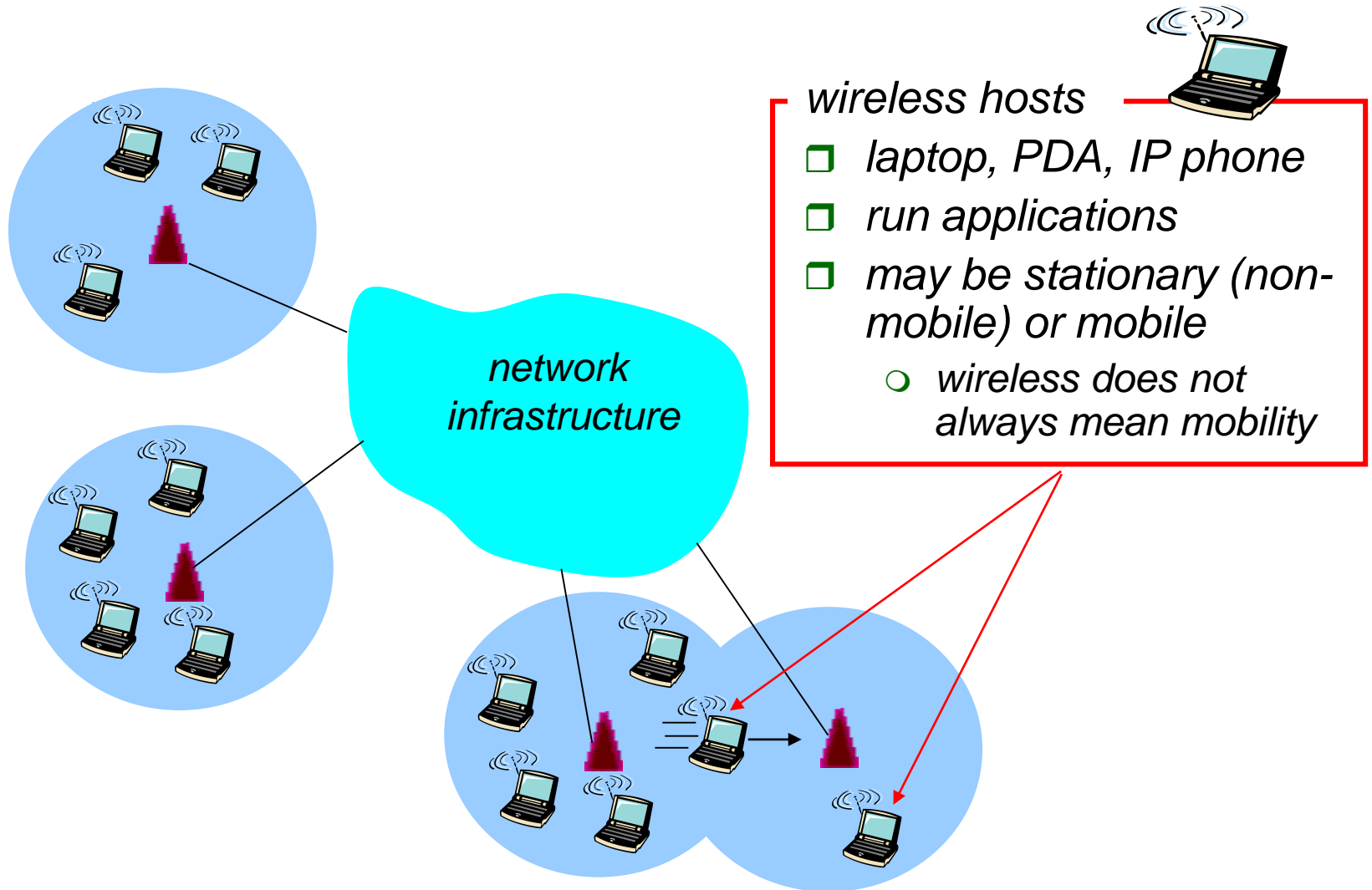

Elements of a wireless network

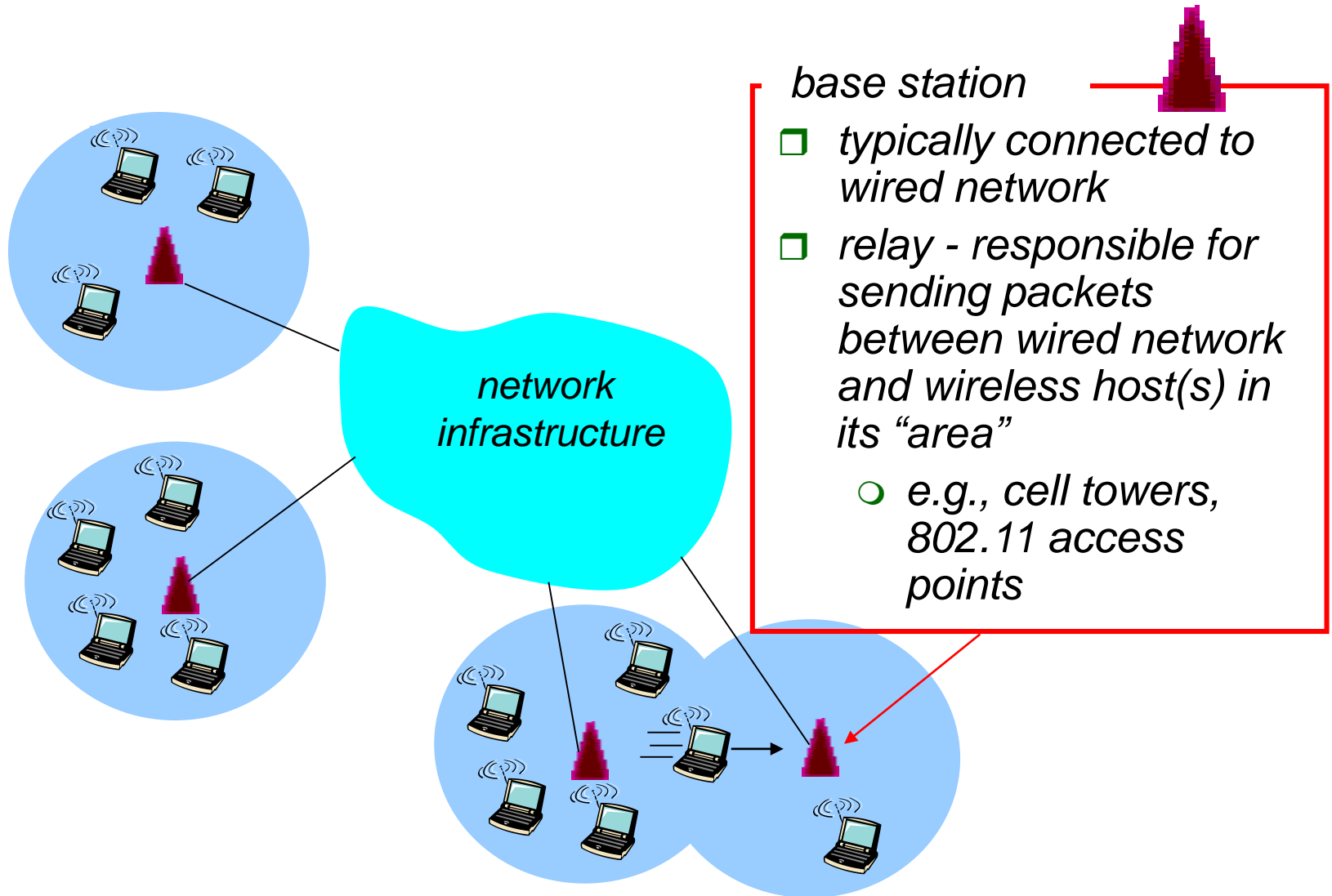

Elements of a wireless network

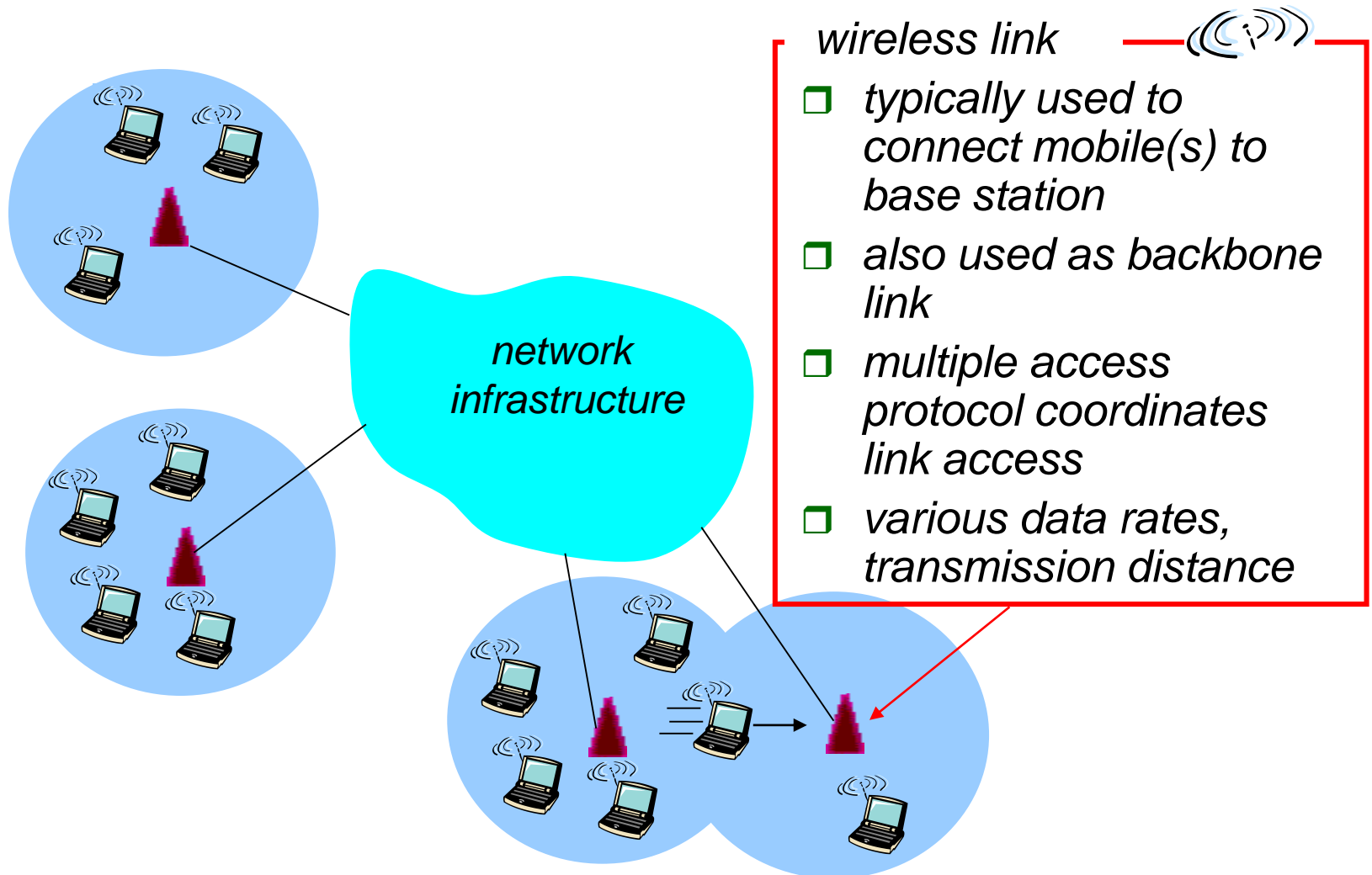

Characteristics of selected wireless link standards



2013: 200 Mbit up to ~7 GBit

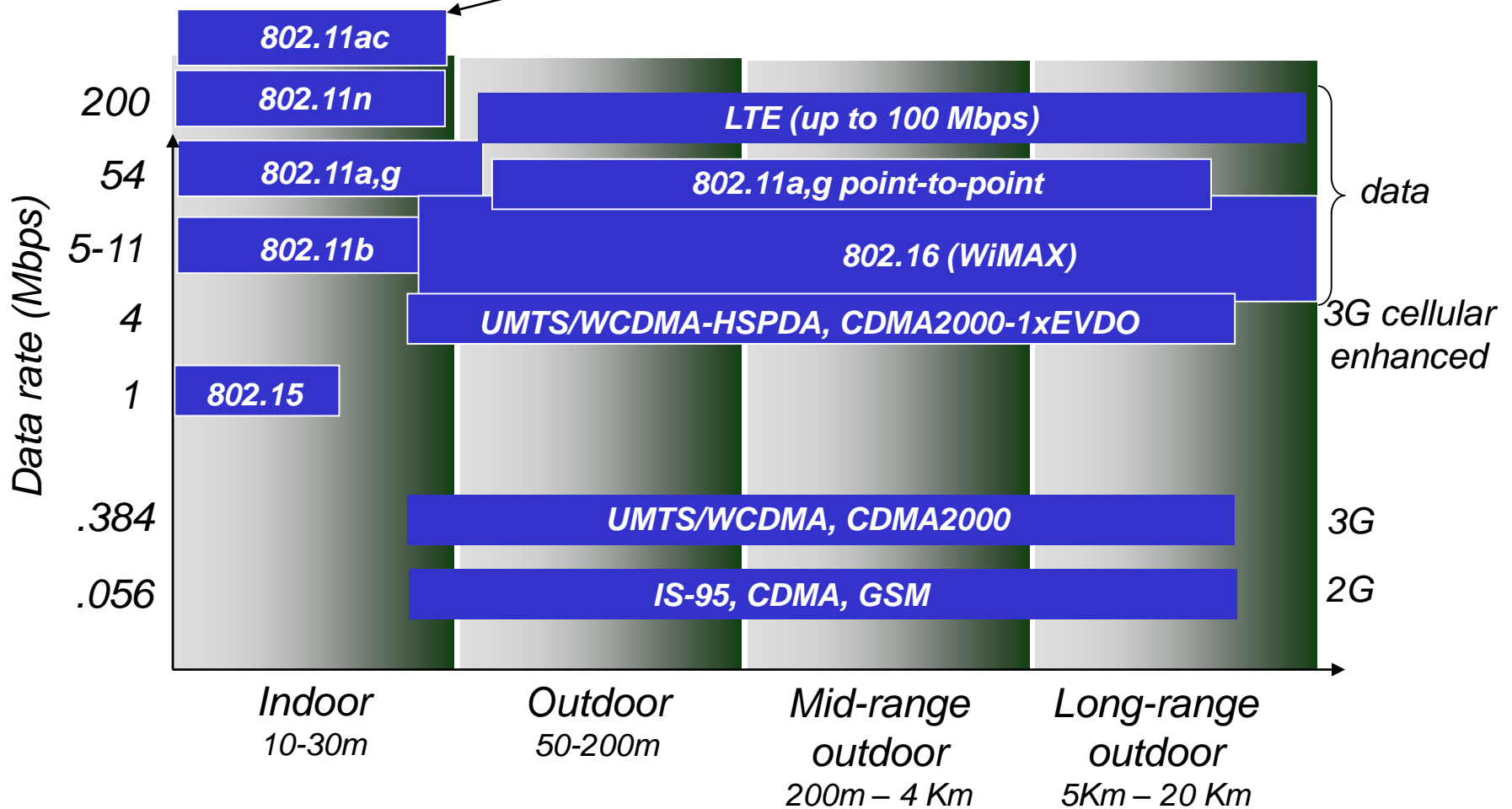

Modes of a wireless network

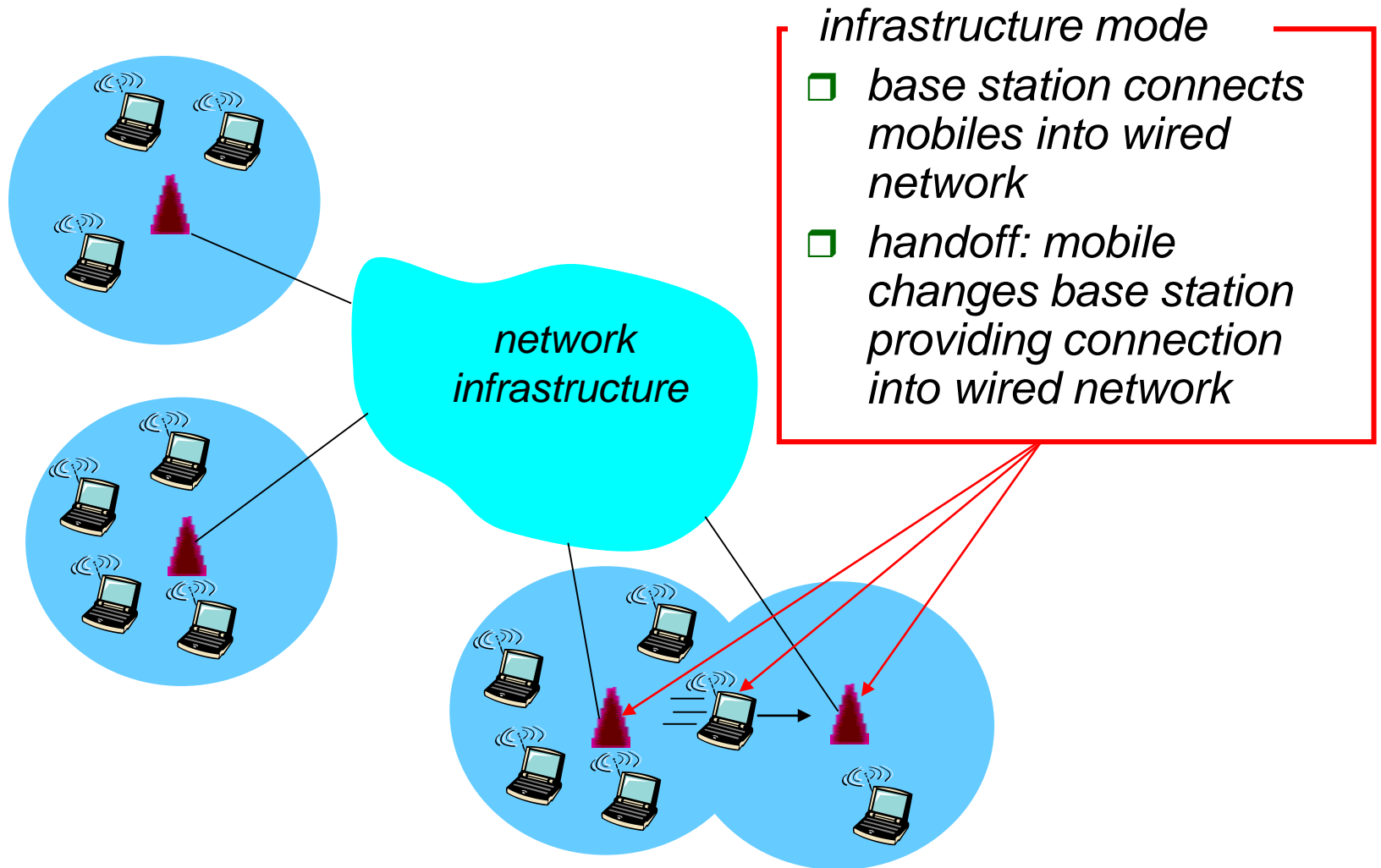

Modes of a wireless network

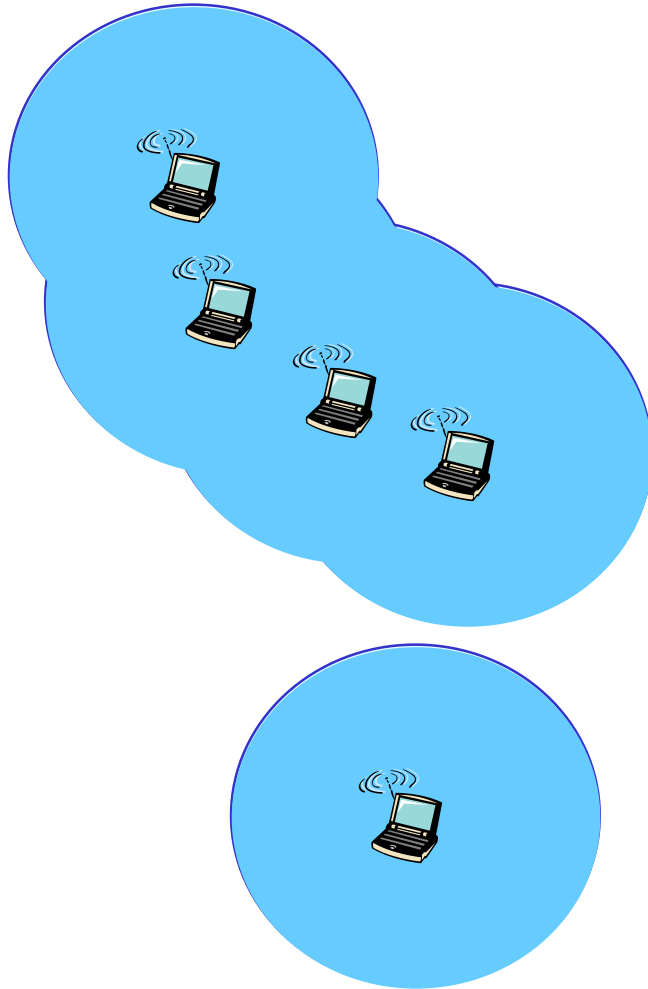

ad hoc mode

- ❑ *no base stations*
- ❑ *nodes can only transmit to other nodes within link coverage*
- ❑ *nodes organize themselves into a network: route among themselves*

Wireless network taxonomy

	<i>single hop</i>	<i>multiple hops</i>
<i>infrastructure (e.g., APs)</i>	<i>host connects to base station (WiFi, WiMAX, cellular) which connects to larger Internet</i>	<i>host may have to relay through several wireless nodes to connect to larger Internet: mesh/sensor net</i>
<i>no infrastructure</i>	<i>no base station, no connection to larger Internet (Bluetooth, ad hoc nets)</i>	<i>no base station, no connection to larger Internet. May have to relay to reach other a given wireless node VANET</i>

Wireless Link Characteristics (1)

Differences from wired link

- **decreased signal strength:** radio signal attenuates as it propagates through matter (path loss)
- **interference from other sources:** standardized wireless network frequencies (e.g., 2.4 GHz) shared by other devices (e.g., phone); devices (motors) interfere as well
- **multipath propagation:** radio signal reflects off objects ground, arriving at destination at slightly different times

.... make communication across (even a point to point) wireless link much more “difficult”

Wireless Link Characteristics (2)

- SNR: signal-to-noise ratio
 - larger SNR – easier to extract signal from noise (a “good thing”)
- *SNR versus BER (bit error rate) tradeoffs*
 - *given physical layer*: increase power → increase SNR → decrease BER
 - Problems?
 - *given SNR*: choose physical layer that meets BER requirement, giving highest throughput
 - SNR may change with mobility: dynamically adapt physical layer (modulation technique, rate)

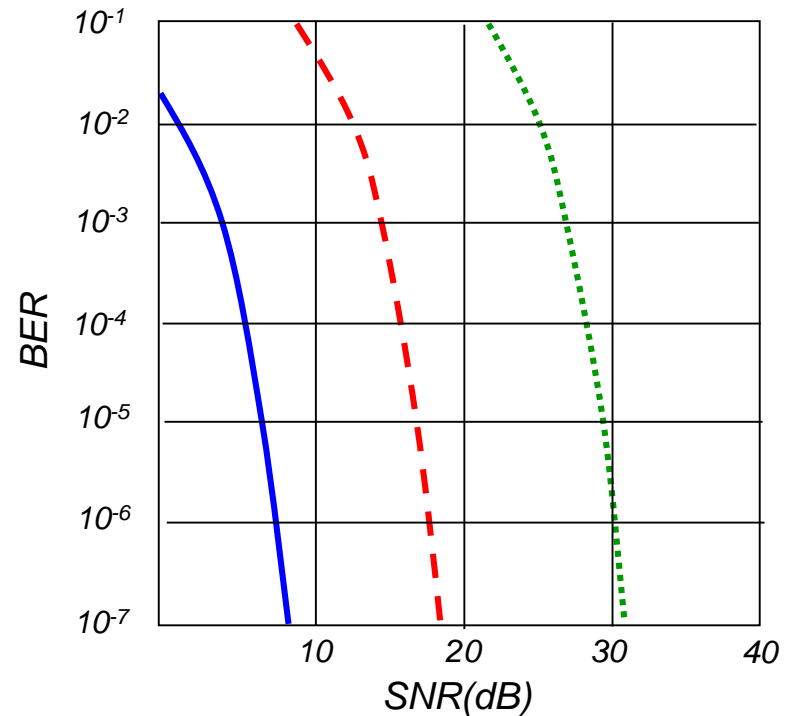

- QAM256 (8 Mbps)
- - - QAM16 (4 Mbps)
- BPSK (1 Mbps)

IEEE 802.11 Wireless LAN

- 802.11b
 - 2.4-5 GHz unlicensed spectrum
 - up to 11 Mbps
 - direct sequence spread spectrum (DSSS) in physical layer
 - all hosts use same chipping code
- 802.11a
 - 5-6 GHz range
 - up to 54 Mbps
- 802.11g
 - 2.4-5 GHz range
 - up to 54 Mbps
- 802.11n/a/c: multiple antennae
 - 2.4-5 GHz range
 - up to 200 Mbps

-
- *all use CSMA/CA for multiple access*
 - *all have base-station and ad-hoc network versions*

802.11 LAN architecture

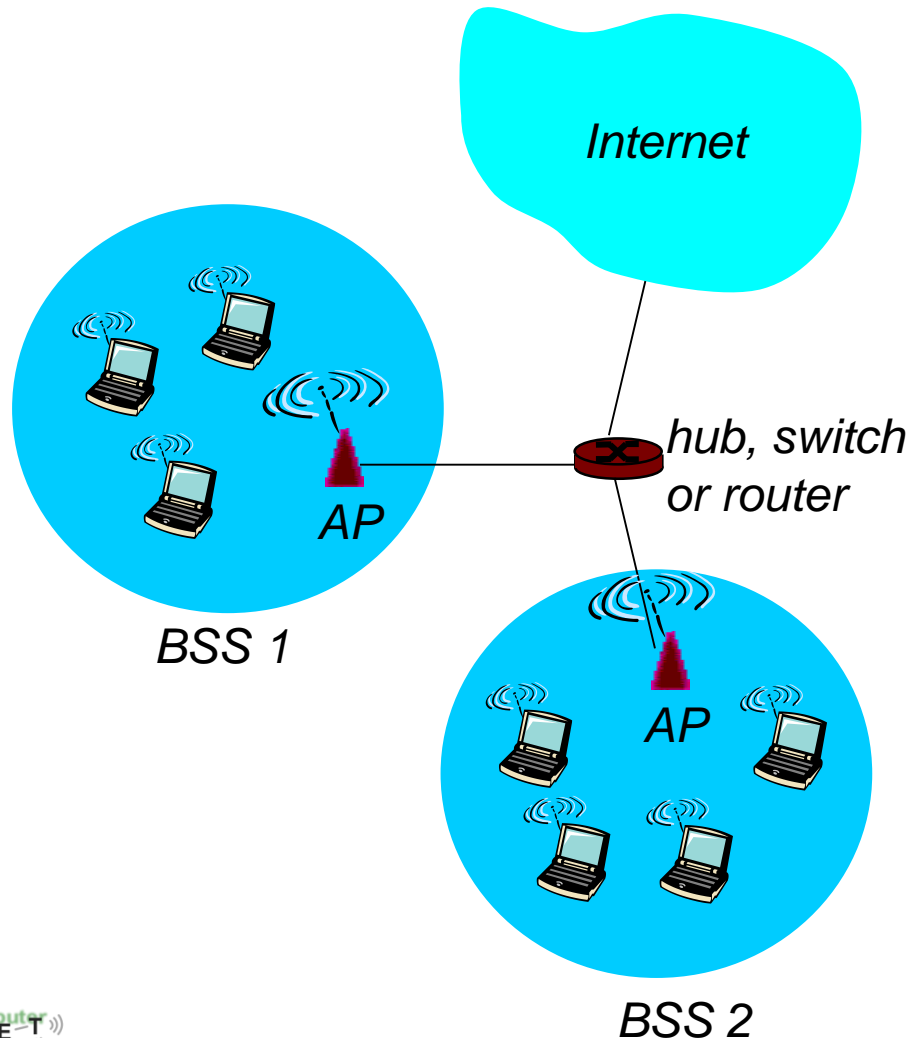

- wireless host communicates with base station
 - base station = access point (AP)
- Basic Service Set (BSS) (aka “cell”) in infrastructure mode contains:
 - wireless hosts
 - access point (AP): base station
 - ad hoc mode: hosts only

802.11: Channels, association

- 802.11b: 2.4GHz-2.485GHz spectrum divided into 11 channels at different frequencies
 - AP admin chooses frequency for AP
 - interference possible: channel can be same as that chosen by neighboring AP!
- host: must *associate* with an AP
 - scans channels, listening for *beacon frames* containing AP's name (SSID) and MAC address
 - selects AP to associate with
 - may perform authentication (later in lecture)
 - will typically run DHCP to get IP address in AP's subnet

802.11: passive/active scanning

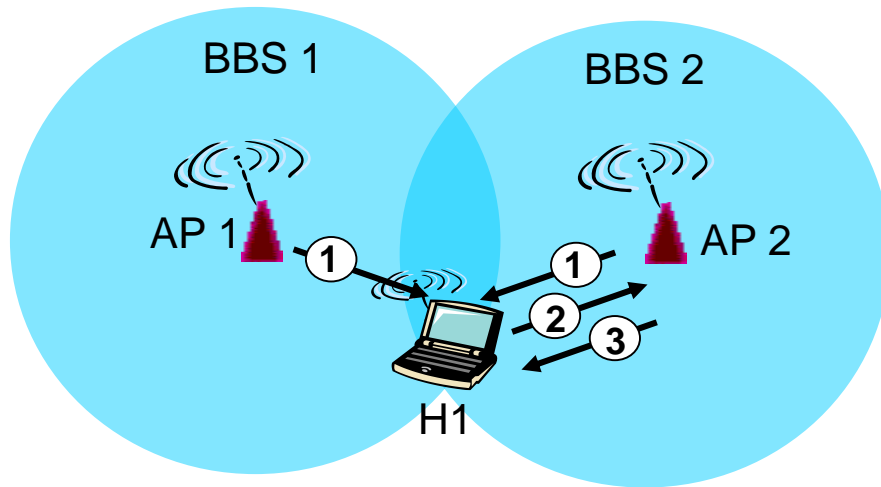

Passive Scanning:

- (1) Beacon frames sent from APs
- (2) Association Request frame sent: H1 to selected AP
- (3) Association Response frame sent: selected AP to H1

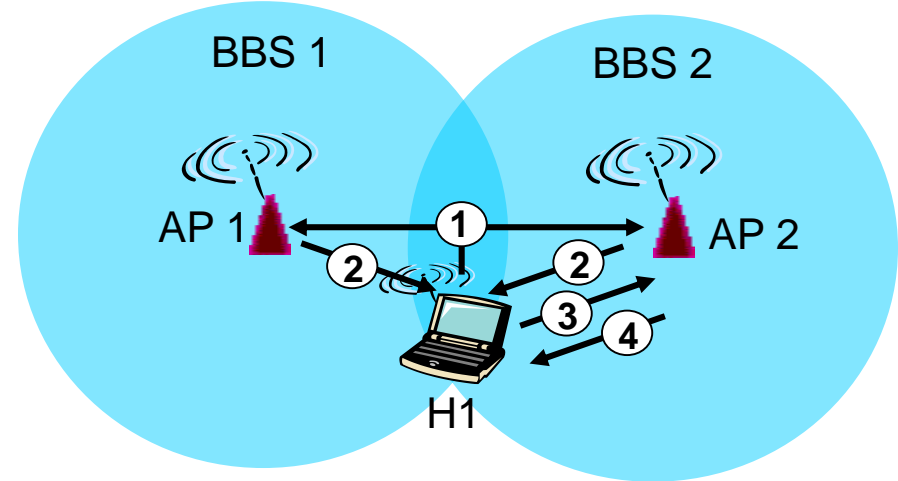

Active Scanning:

- (1) Probe Request frame broadcast from H1
- (2) Probes response frame sent from APs
- (3) Association Request frame sent: H1 to selected AP
- (4) Association Response frame sent: selected AP to H1

Wireless network characteristics

Multiple wireless senders and receivers create additional problems (beyond multiple access):

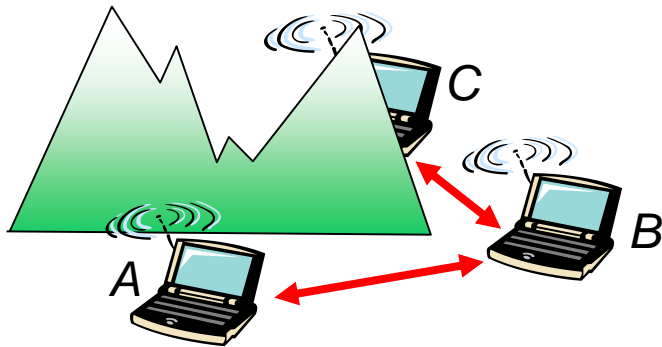

Hidden terminal problem

- B, A hear each other
 - B, C hear each other
 - A, C can not hear each other
- > means A, C unaware of their interference at B

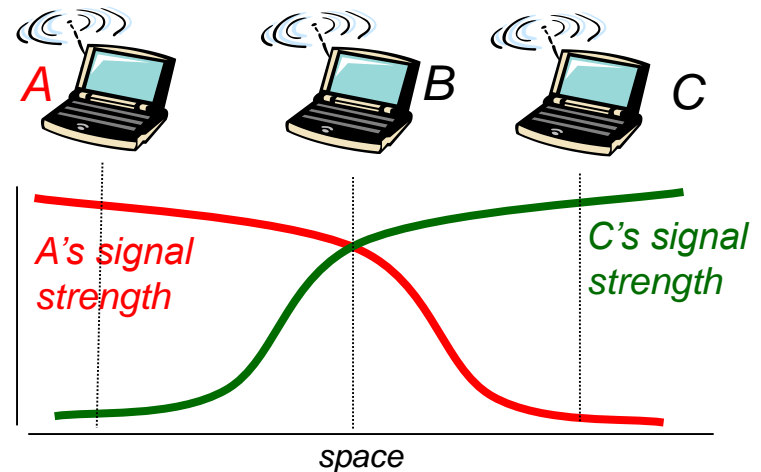

Signal attenuation:

- B, A hear each other
- B, C hear each other
- A, C can not hear each other interfering at B

IEEE 802.11: multiple access

- avoid collisions: 2+ nodes transmitting at same time
- 802.11: CSMA - sense before transmitting
 - don't collide with ongoing transmission by other node
- 802.11: *no* collision detection!
 - difficult to receive (sense collisions) when transmitting due to weak received signals (fading)
 - can't sense all collisions in any case: hidden terminal, fading
 - goal: *avoid collisions*: CSMA/C(ollision)A(voidance)

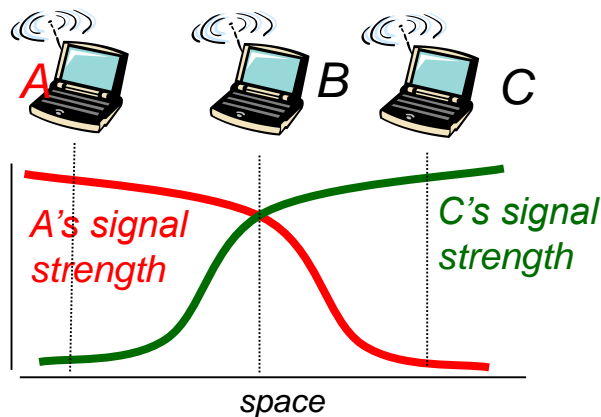
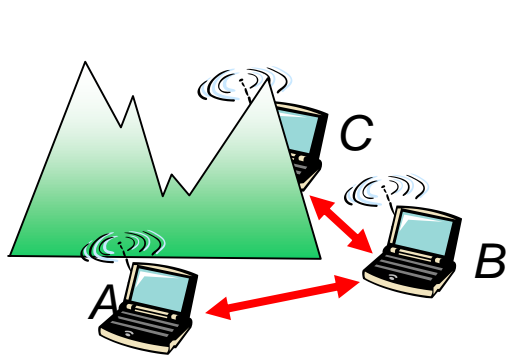

IEEE 802.11 MAC Protocol: CSMA/CA

802.11 sender

- 1 if sense channel idle for **DIFS** then
transmit entire frame (no CD)
- 2 if sense channel busy then
start random backoff time
timer counts down while channel idle
transmit when timer expires
if no ACK, increase random backoff interval,
repeat 2

802.11 receiver

- if frame received OK
return ACK after **SIFS** (ACK needed due to
hidden terminal problem)

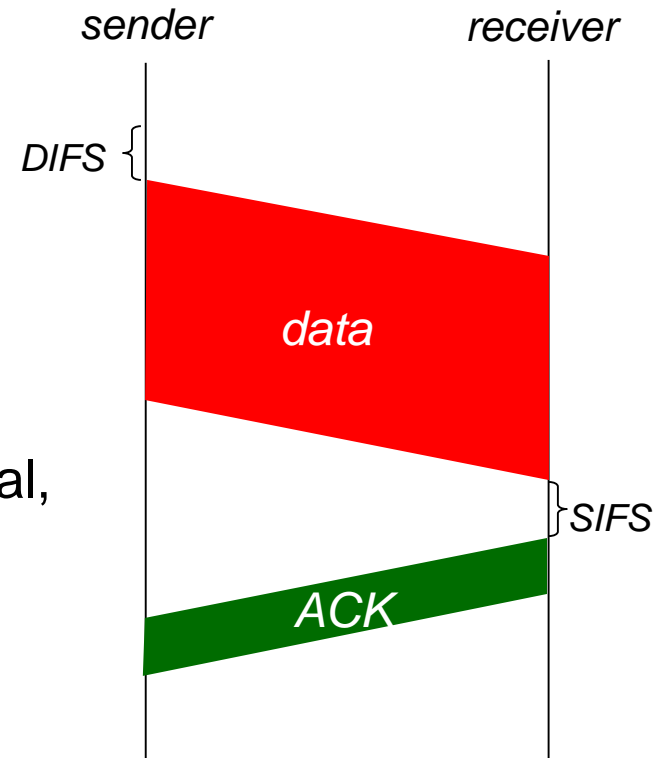

Avoiding collisions (more)

- idea:* allow sender to “reserve” channel rather than random access of data frames: avoid collisions of long data frames
- sender first transmits *small* request-to-send (RTS) packets to BS using CSMA
 - RTSs may still collide with each other (but they’re short)
 - BS broadcasts clear-to-send CTS in response to RTS
 - CTS heard by all nodes
 - sender transmits data frame
 - other stations defer transmissions

*avoid data frame collisions completely
using small reservation packets!*

Collision Avoidance: RTS-CTS exchange

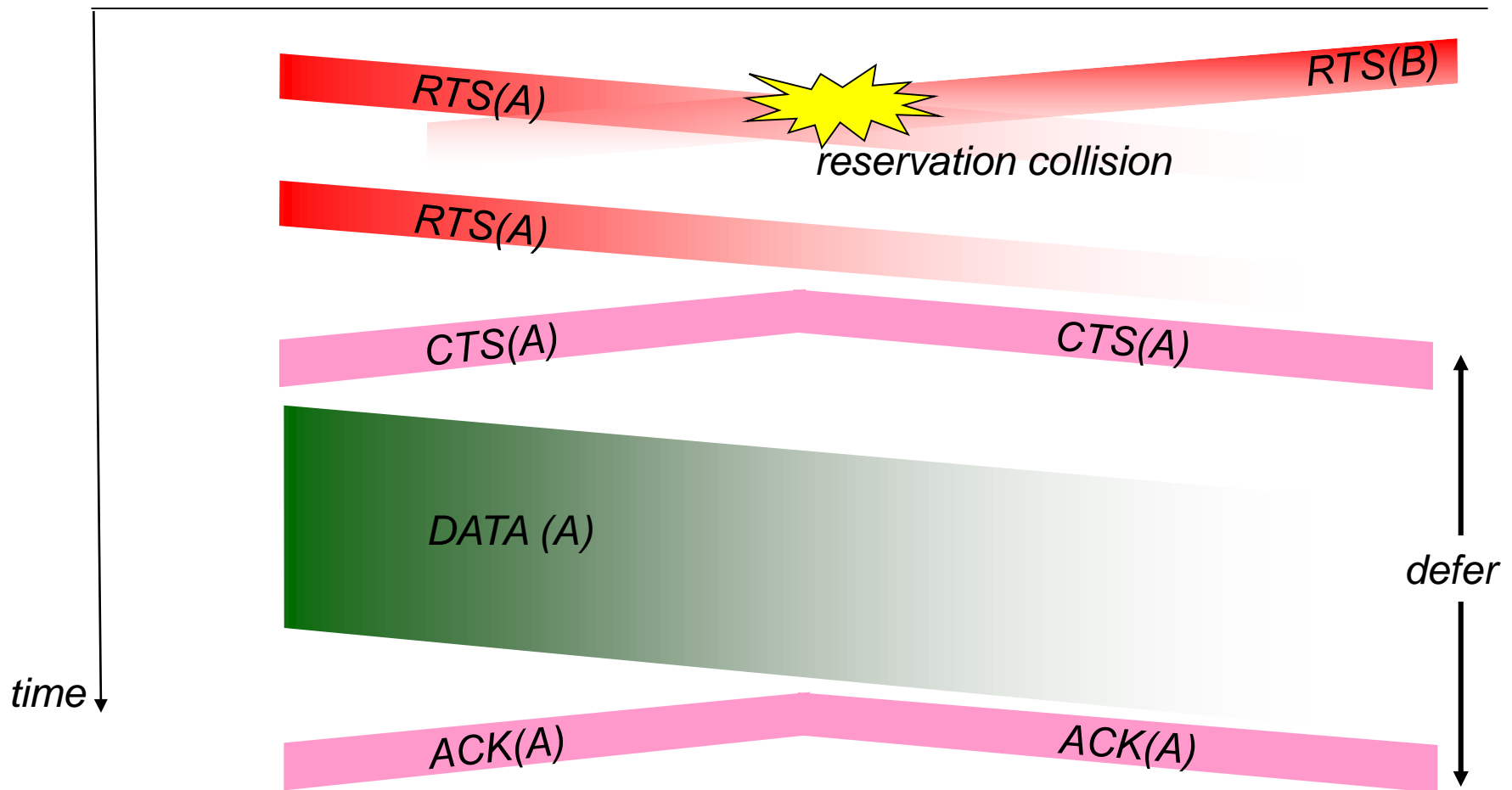

802.11 frame: addressing



Address 1: MAC address of wireless host or AP to receive this frame

Address 2: MAC address of wireless host or AP transmitting this frame

Address 3: MAC address of router interface to which AP is attached

Address 4: used only in ad hoc mode

802.11 frame: addressing

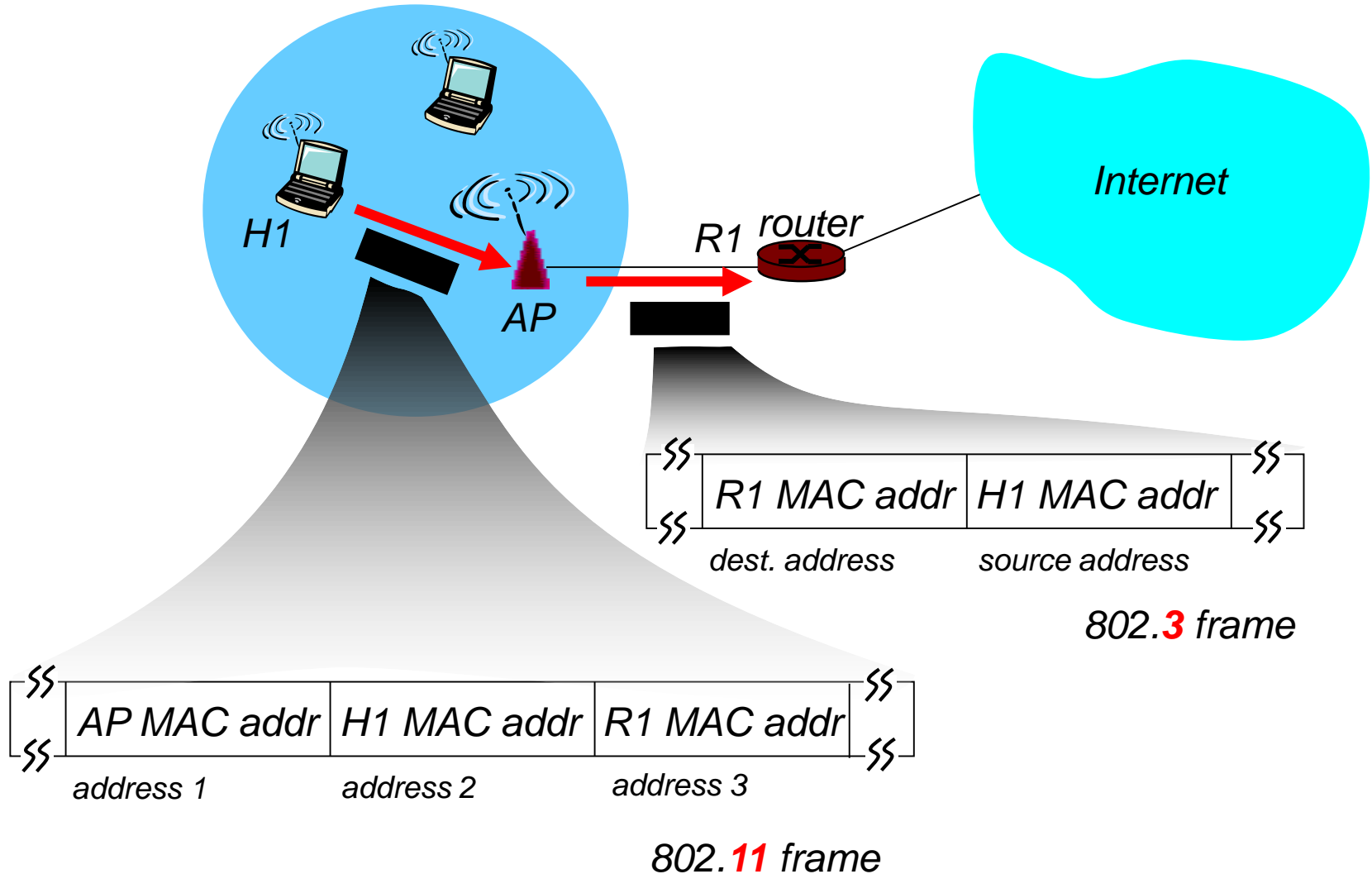

802.11 frame: more

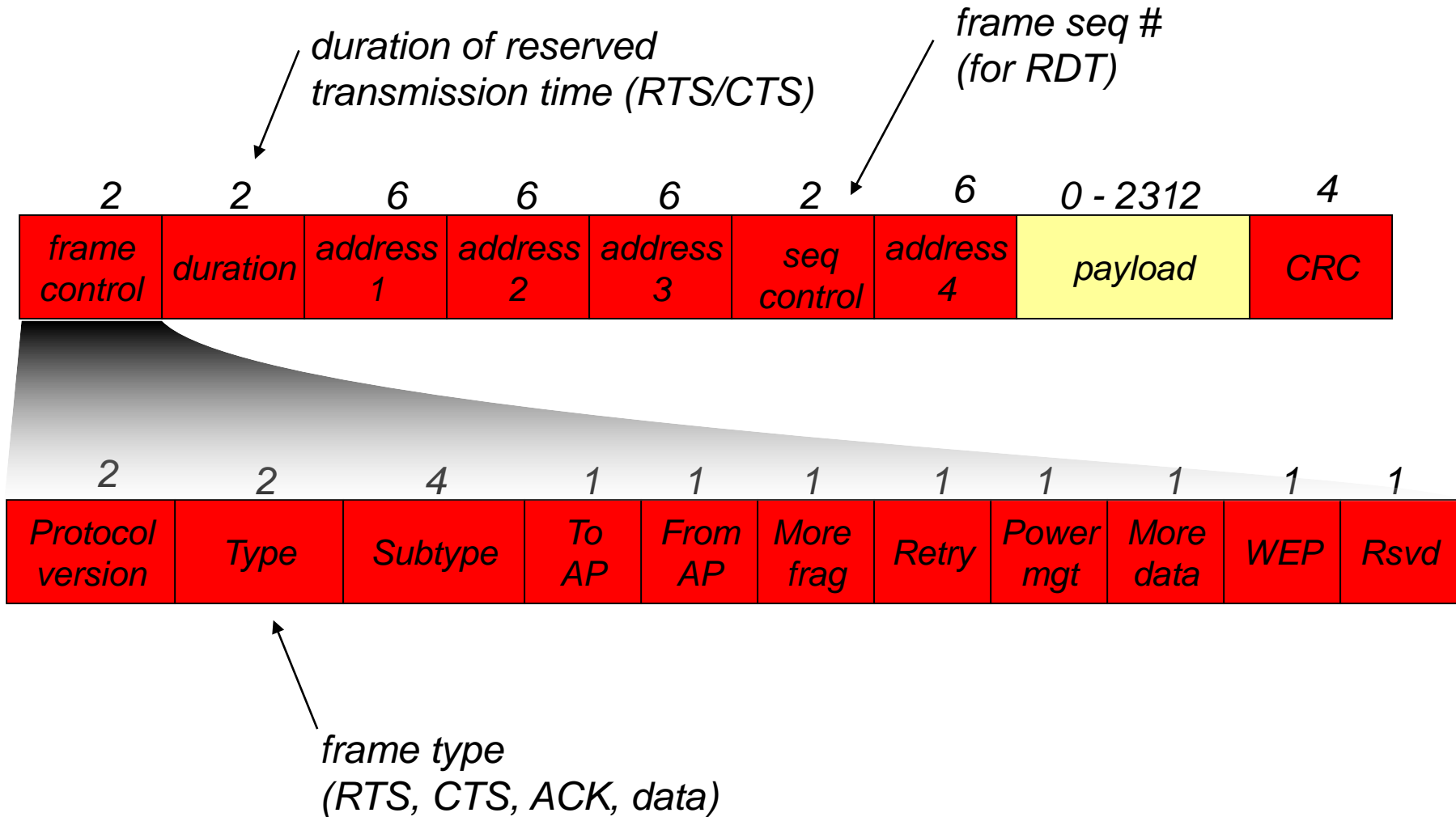

802.11: mobility within same subnet

- H1 remains in same IP subnet: IP address can remain same
- switch: which AP is associated with H1?
 - self-learning (again): switch will see frame from H1 and “remember” which switch port can be used to reach H1

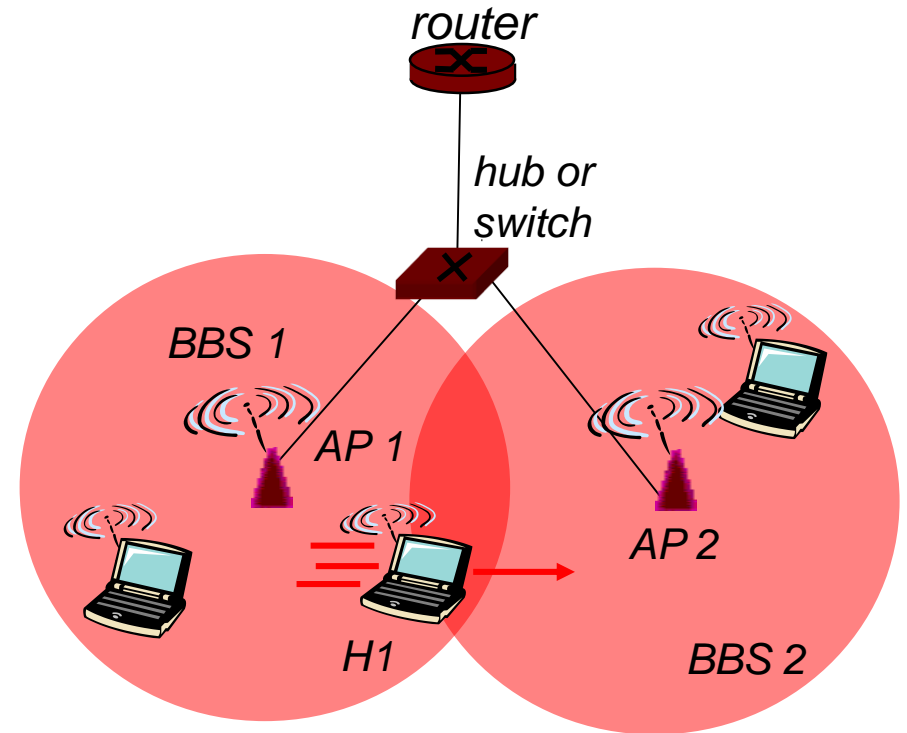

802.11: advanced capabilities

Rate Adaptation

- base station, mobile dynamically change transmission rate (physical layer modulation technique) as mobile moves, SNR varies

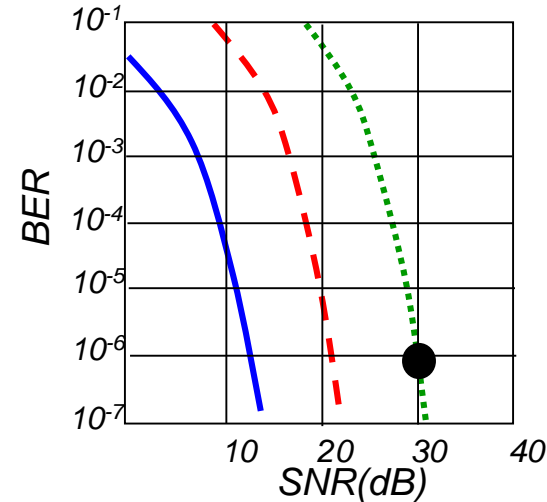
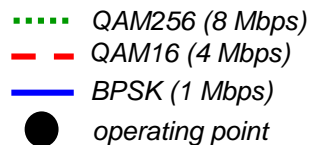

1. SNR decreases, BER increase as node moves away from base station
2. When BER becomes too high, switch to lower transmission rate but with lower BER

802.11: advanced capabilities

- Power Management
- node-to-AP: “I am going to sleep until next beacon frame”
 - AP knows not to transmit frames to this node
 - node wakes up before next beacon frame
- beacon frame: contains list of mobiles with AP-to-mobile frames waiting to be sent
 - node will stay awake if AP-to-mobile frames to be sent; otherwise sleep again until next beacon frame

802.15: personal area network

- less than 10 m diameter
- replacement for cables (mouse, keyboard, headphones)
- ad hoc: no infrastructure
- master/slaves:
 - slaves request permission to send (to master)
 - master grants requests
- 802.15: evolved from Bluetooth specification
 - 2.4-2.5 GHz radio band
 - up to 721 kbps

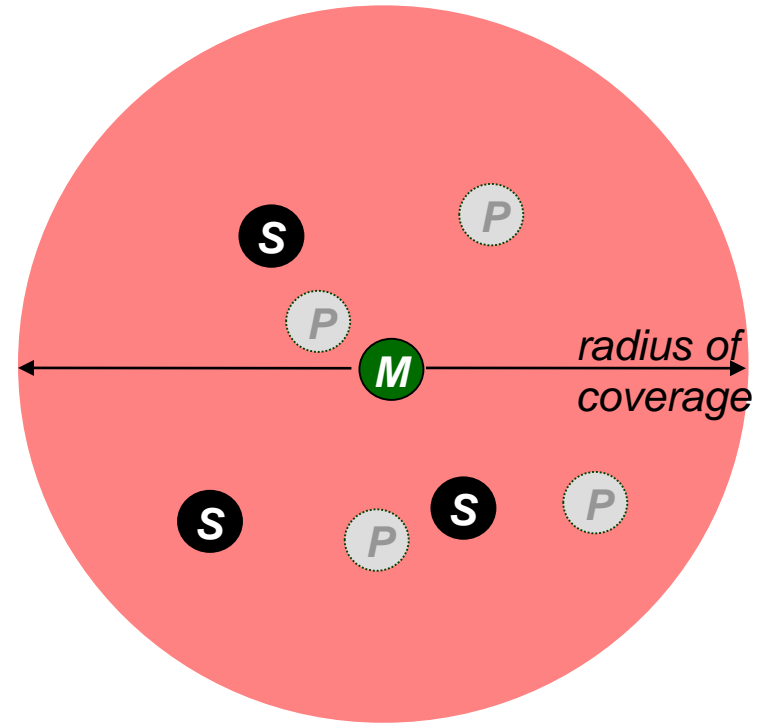

- M** Master device
- S** Slave device
- P** Parked device (inactive)

802.16: WiMAX

- like 802.11 & cellular:
base station model
 - transmissions to/from base station by hosts with omnidirectional antenna
 - base station-to-base station backhaul with point-to-point antenna
- unlike 802.11:
 - range ~ 6 miles (“city rather than coffee shop”)
 - ~14 Mbps

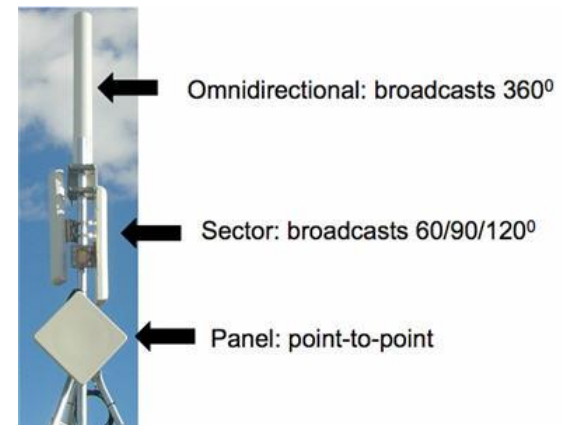
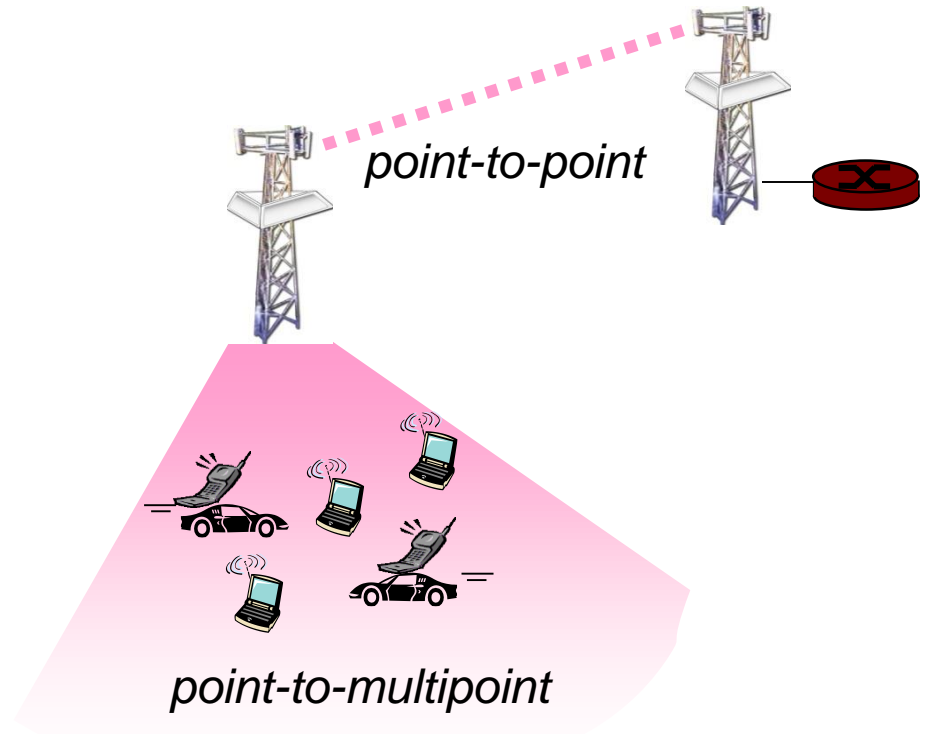

Link Layer

- 2.1 Introduction and services
- 2.2 Error detection and correction
- 2.3 Multiple access protocols
- 2.4 Link-Layer Addressing
- 2.5 Ethernet
- 2.6 Link-layer switches
- 2.7 PPP
- 2.8 Wireless links / Wi-Fi
- 2.9 Link Virtualization: ATM, MPLS

What is a link?

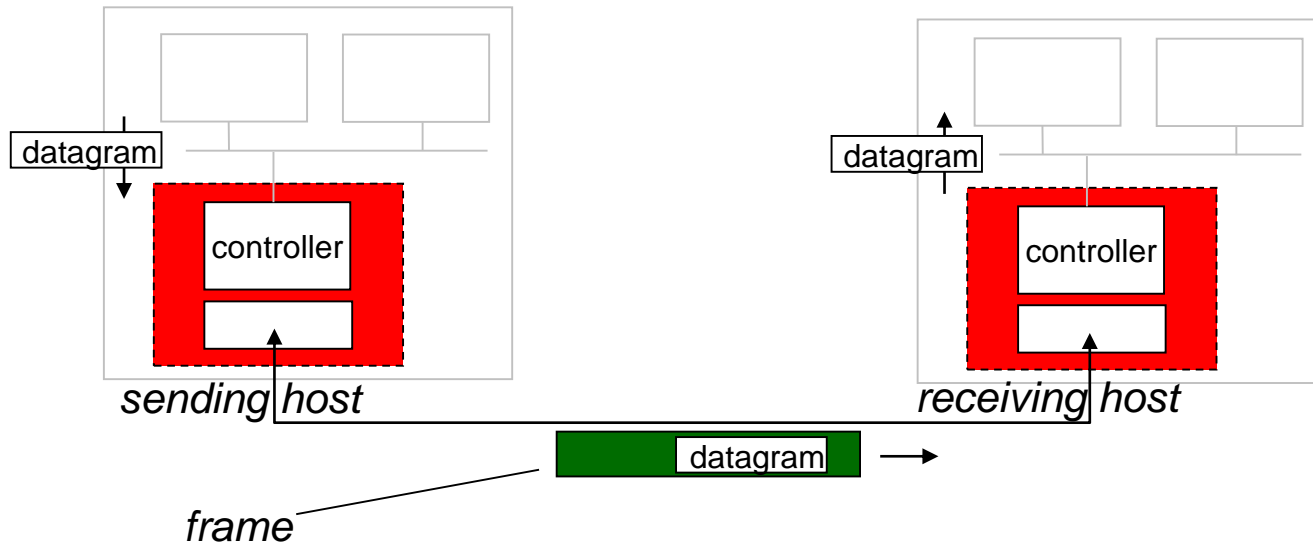

- Single wire
- Switched, transparent infrastructure
- Wireless
- PPP link

What are links?

- Layers above see whole networks as links/medium
- E.g., a switched infrastructure may be seen as a single link by layer 3 protocols

Abstraction!

- Also see: programming abstractions:
 - Example: interfaces in Java: they provide a functionality, but the programmer does not need to know how that functionality is realized internally
 - Here: datagrams can be forwarded from one host to the next, but the upper layer does not need to know how the forwarding is done internally

Virtualization of networks

Virtualization of resources: powerful abstraction in systems engineering:

- computing examples: virtual memory, virtual devices
 - Virtual machines: e.g., in cloud computing
- layering of abstractions: don't sweat the details of the lower layer, only deal with lower layers abstractly

Virtualization of networks

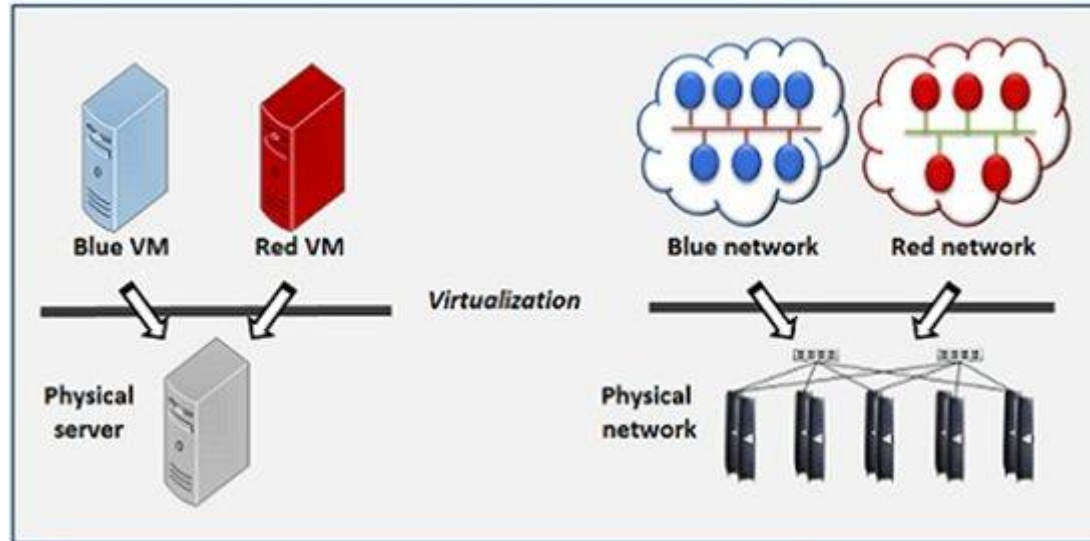

Huge research topic in datacenter networks (see our Master level courses)

The Internet: virtualizing networks

1974: multiple unconnected nets ... differing in:

- ARPAnet
- data-over-cable networks
- packet satellite network (Aloha)
- packet radio network
- addressing conventions
- packet formats
- error recovery
- routing

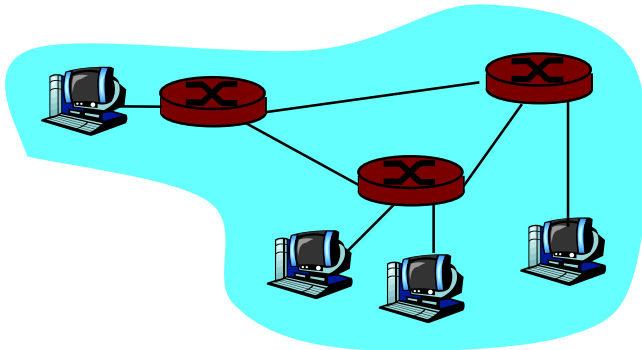

ARPAnet

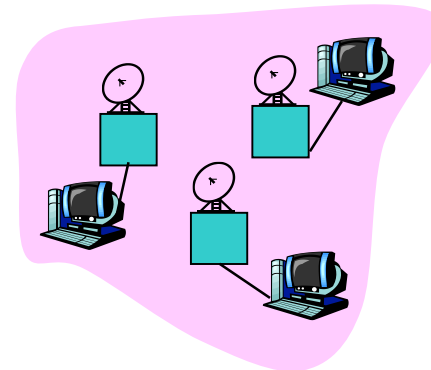

satellite net

The Internet: virtualizing networks

Internetwork layer (IP):

- addressing: internetwork appears as single, uniform entity, despite underlying local network heterogeneity
- network of networks

Gateway:

- “embed internetwork packets in local packet format or extract them”
- route (at internetwork level) to next gateway

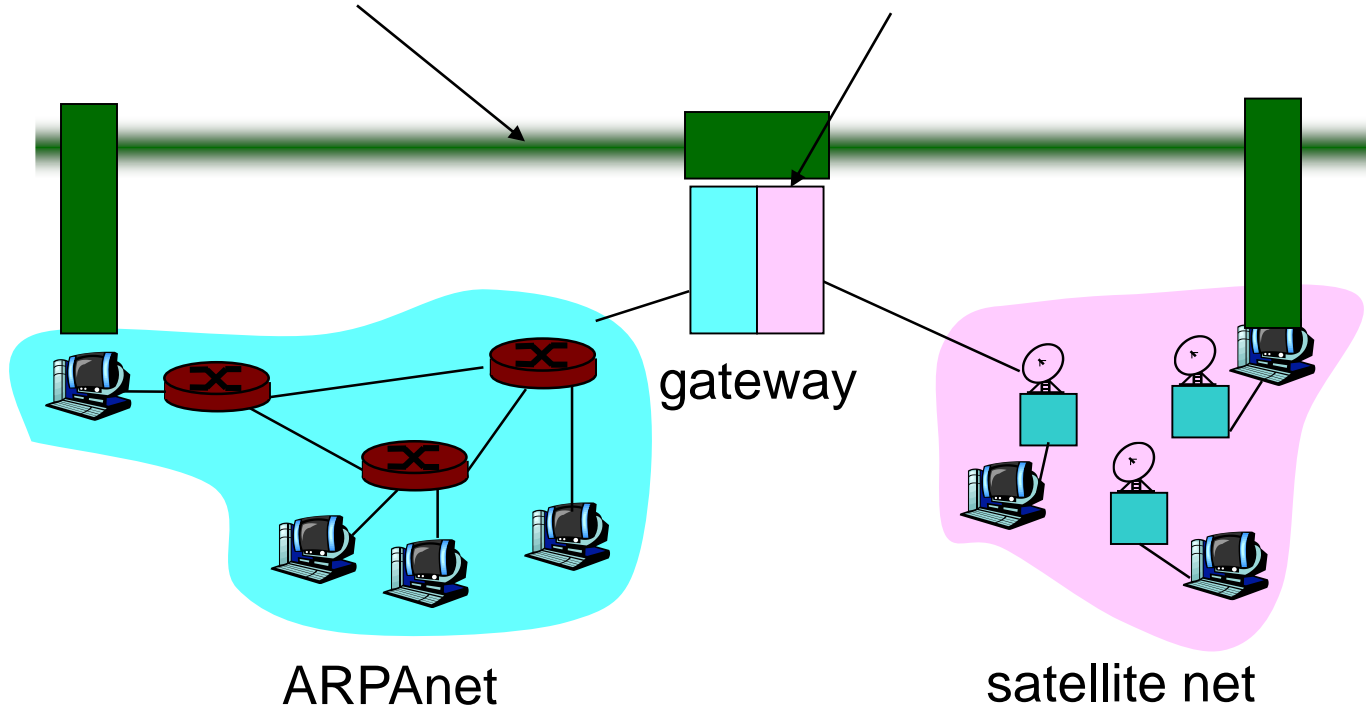

Cerf & Kahn's Internetwork Architecture

What is virtualized?

- two layers of addressing: internetwork and local network
 - new layer (IP) makes everything homogeneous at internetwork layer
 - underlying local network technology
 - cable
 - satellite
 - 56K telephone modem
 - today: ATM, MPLS
- ... “invisible” at internetwork layer. Looks like a link layer technology to IP!

ATM and MPLS

- ATM, MPLS separate networks in their own right
 - different service models, addressing, routing from Internet
- viewed by Internet as logical link connecting IP routers
 - just like dialup link is really part of separate network (telephone network)
- ATM, MPLS: of technical interest in their own right

Multiprotocol label switching (MPLS)

- initial goal: speed up IP forwarding by using fixed length label (instead of IP address) to do forwarding
 - borrowing ideas from Virtual Circuit (VC) approach
 - but IP datagram still keeps IP address!

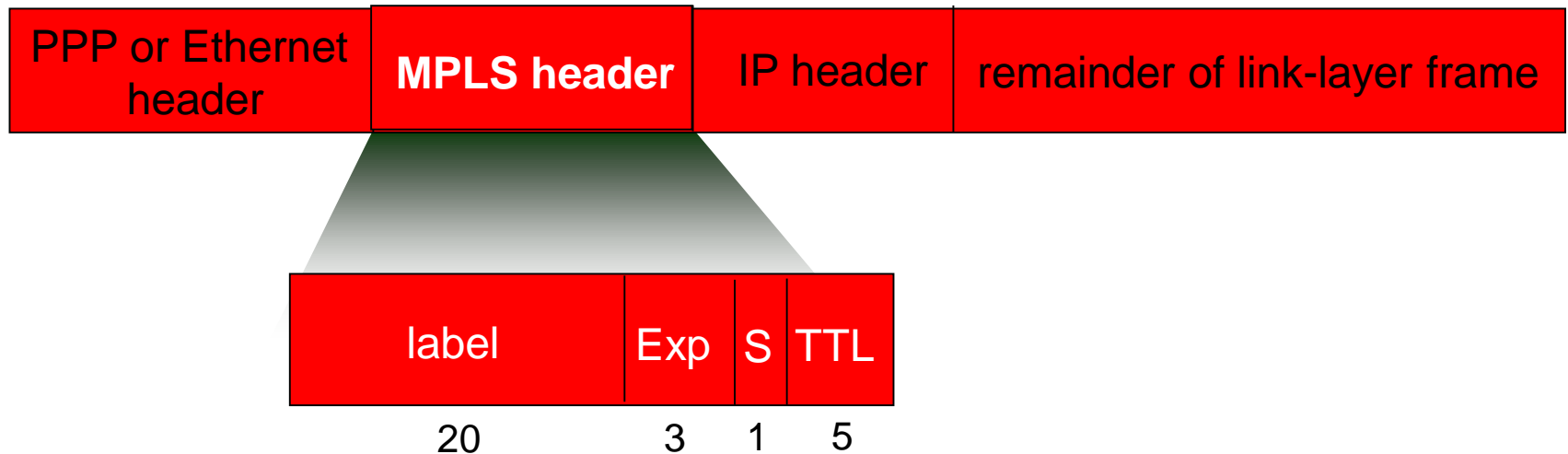

MPLS capable routers

- a.k.a. label-switched router
- forwards packets to outgoing interface based only on label value (don't inspect IP address)
 - MPLS forwarding table distinct from IP forwarding tables
- signaling protocol needed to set up forwarding
 - RSVP-TE (later in the lecture)
 - forwarding possible along paths that IP alone would not allow (e.g., source-specific routing) !!
 - use MPLS for traffic engineering
- must co-exist with IP-only routers

MPLS forwarding tables

*Traffic engineering: big topic, too
Again: Master courses!*

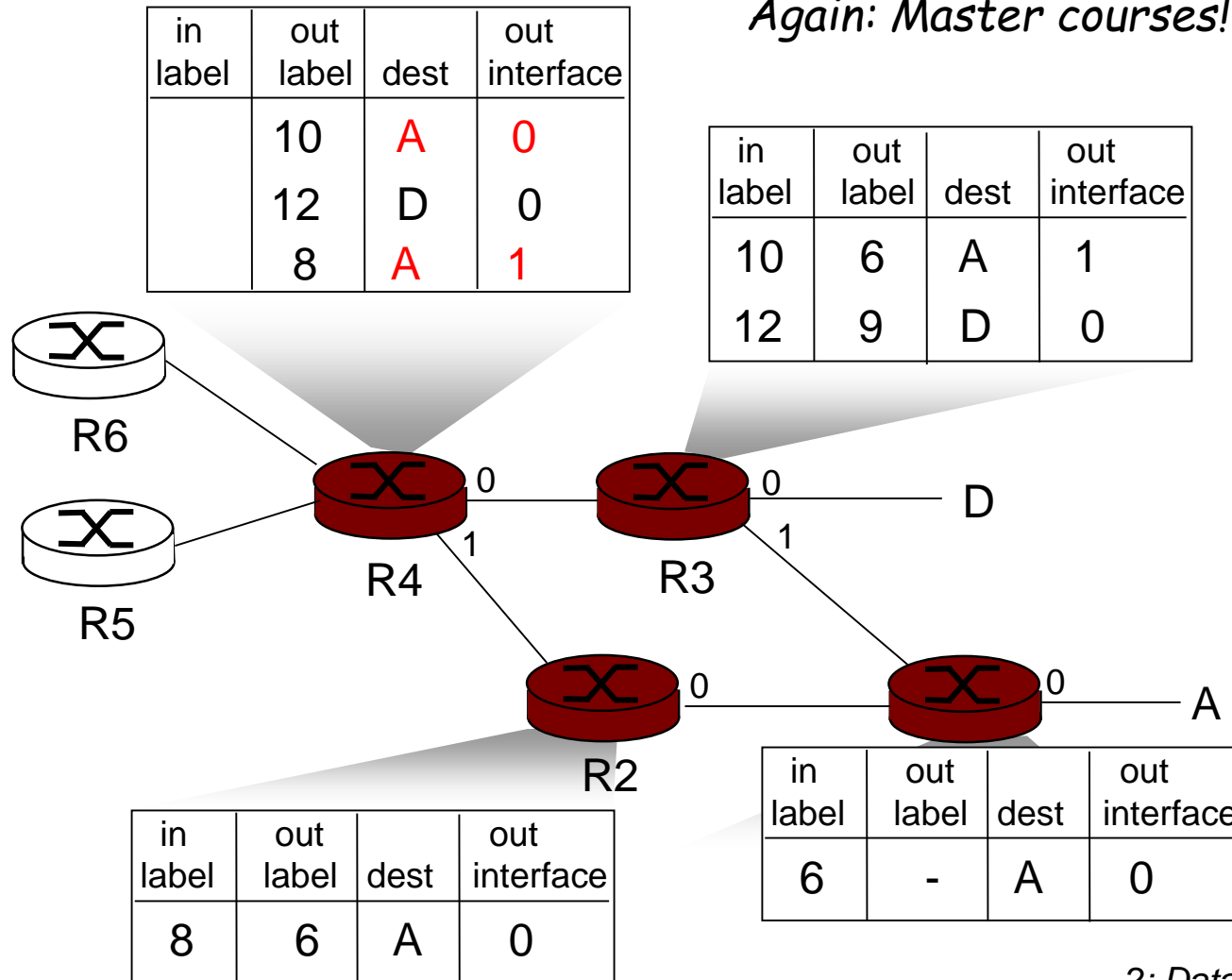

Chapter 2: Summary

- principles behind data link layer services:
 - error detection, correction
 - sharing a broadcast channel: multiple access
 - link layer addressing
- instantiation and implementation of various link layer technologies
 - switched LANS
 - PPP
 - Wireless links
 - virtualized networks as a link layer: ATM, MPLS